

<b>WEIGHT</b>	<b>67 kg / 147 lb</b>
<b>TIRES CAPACITY</b>	<b>1</b>
<b>LOAD CAPACITY</b>	<b>85 kg / 187 lb</b>

THIS DRAWING AND THE INFORMATION CONTAINED IN THIS DOCUMENT IS THE PROPERTY OF INDUSTRIES MARTINS INC. AND SHALL NOT BE REPRODUCED, COPIED, MODIFIED, OR USED WITHOUT THE WRITTEN PERMISSION OF INDUSTRIES MARTINS INC.

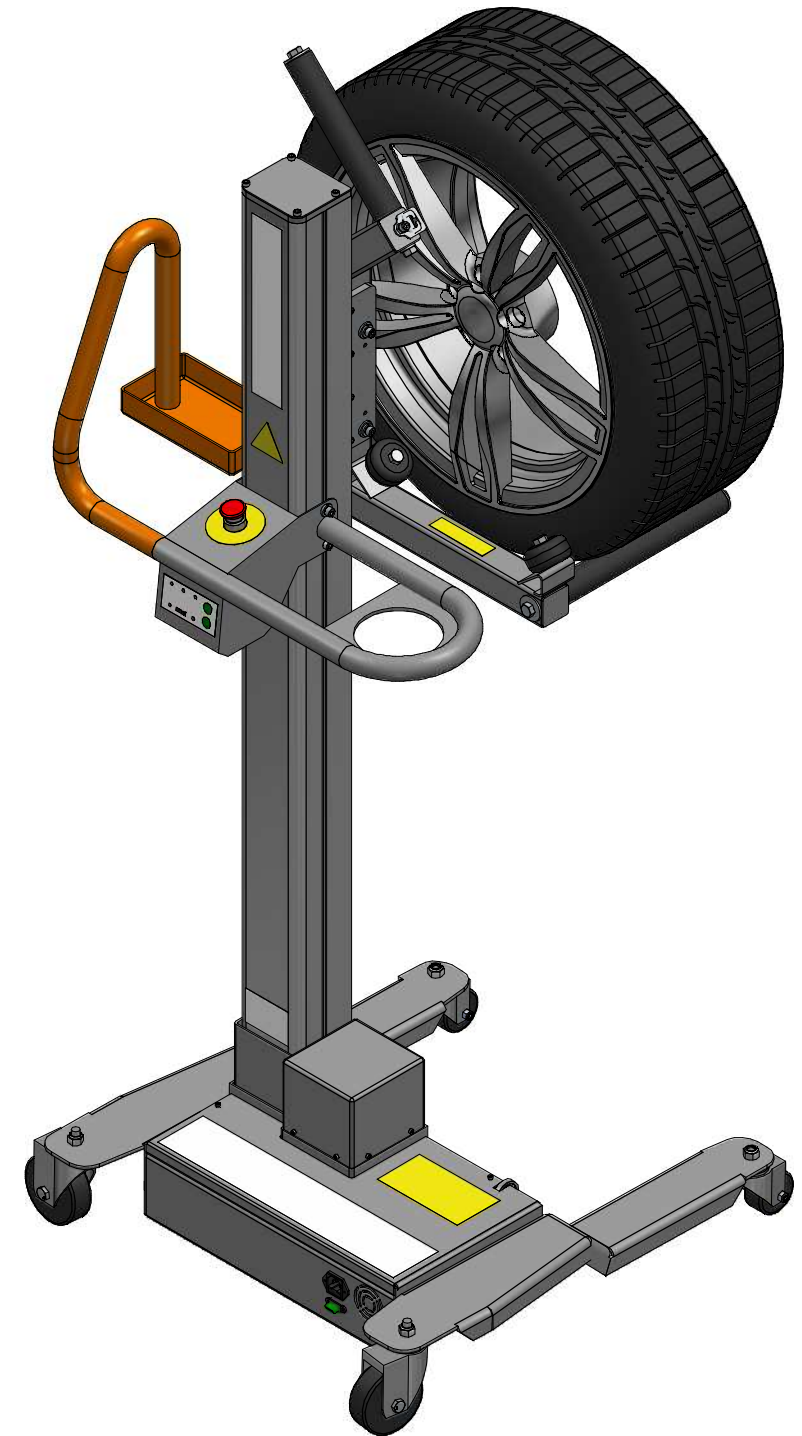
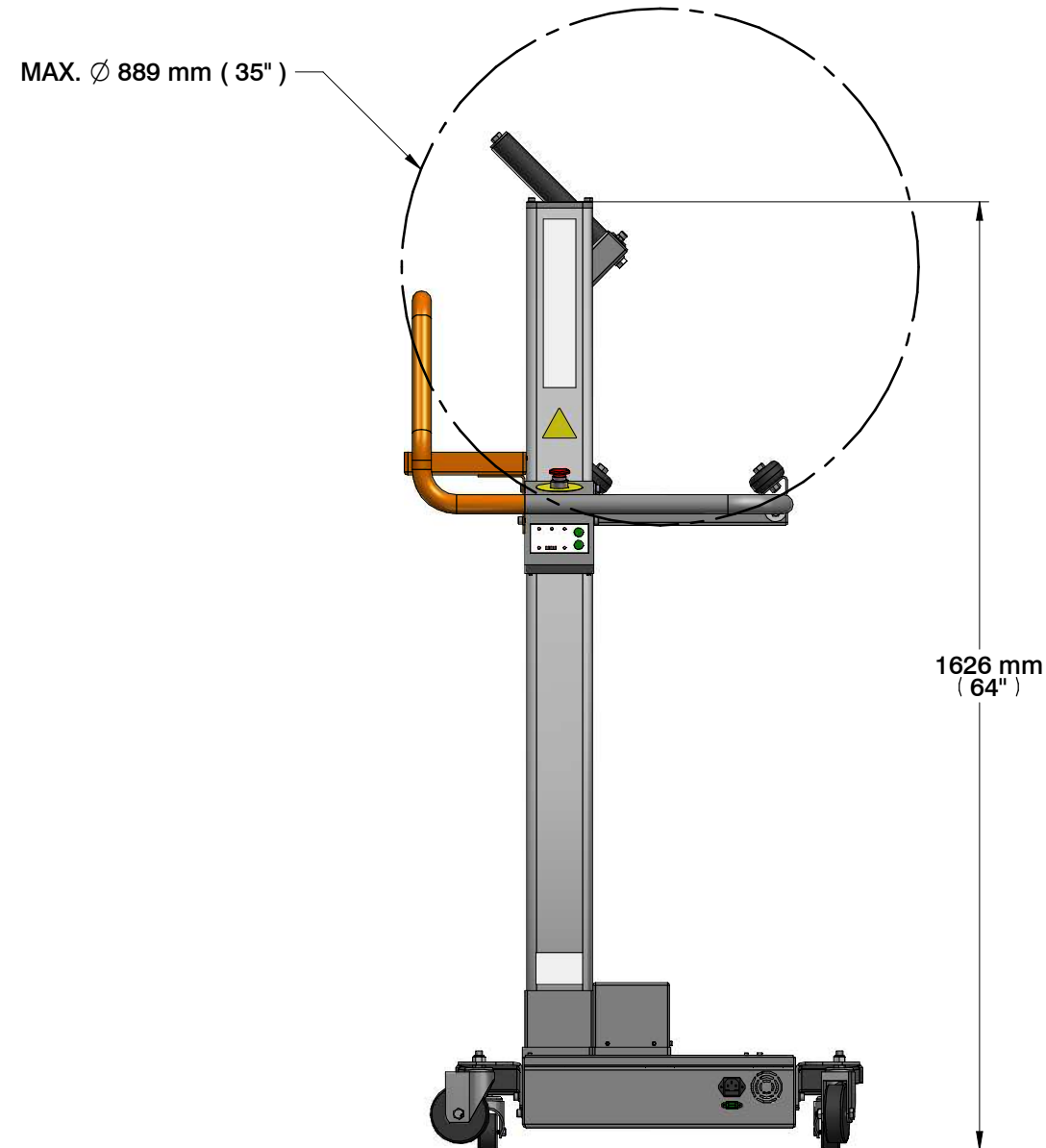
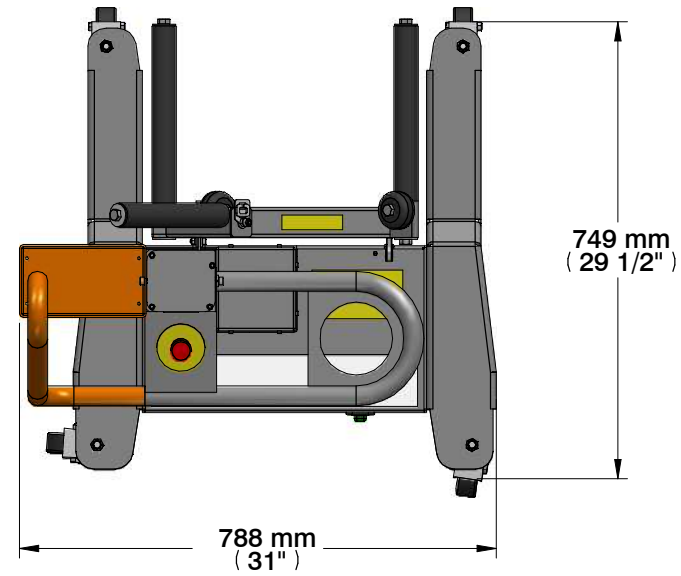
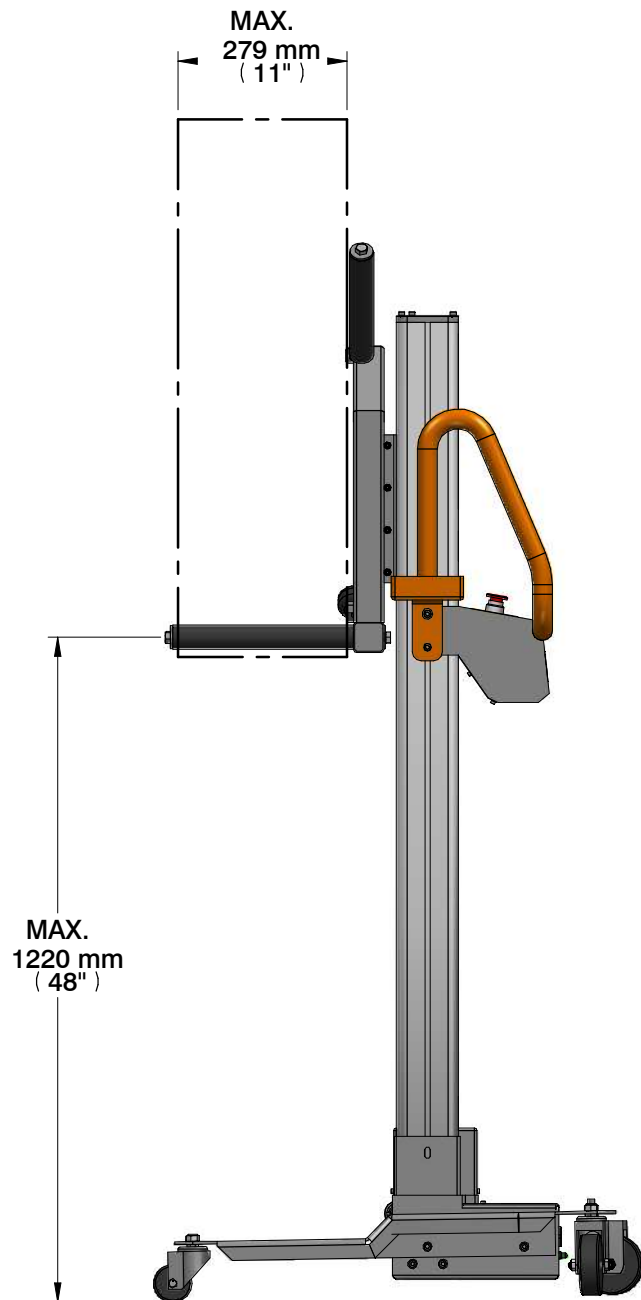

<b>WEIGHT</b>	<b>67 kg / 147 lb</b>
<b>TIRES CAPACITY</b>	<b>1</b>
<b>LOAD CAPACITY</b>	<b>85 kg / 187 lb</b>

THIS DRAWING AND THE INFORMATION CONTAINED IN THIS DOCUMENT IS THE PROPERTY OF INDUSTRIES MARTINS INC. AND SHALL NOT BE REPRODUCED, COPIED, MODIFIED, OR USED WITHOUT THE WRITTEN PERMISSION OF INDUSTRIES MARTINS INC.

